

DMS-36296, Rev. D; Approved June 2, 2023



CorNeat EverPatch
Permanent Tissue-Integrating Surgical Matrix
5.0 mm x 6.5 mm x 100 μ m

INSTRUCTIONS
FOR USE

Device Description

The CorNeat EverPatch is a synthetic permanent tissue-integrating surgical matrix made of non-degradable polymer fibers. The CorNeat EverPatch includes 6 bio-stitching holes which are intended to anchor the device to support its bio-integration. The holes at each corner guide the physician to suture the device to the sclera.

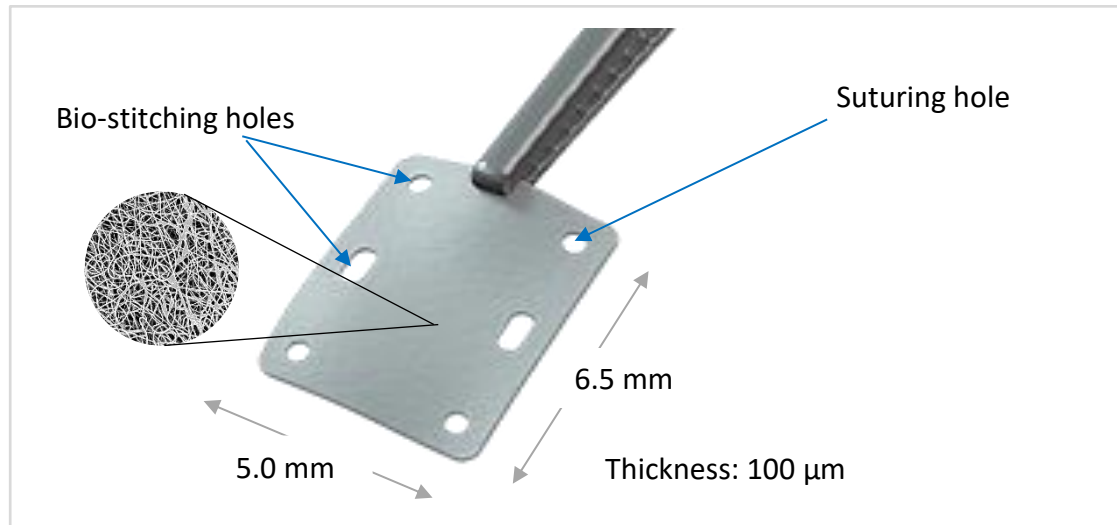

Structure, features, and dimensions of the CorNeat EverPatch

Indication for Use

The CorNeat EverPatch is intended for implantation to reinforce the sclera and aid the physical reconstruction of the ocular surface.

Contraindication

The CorNeat EverPatch should not be used in surgical sites where active inflammation of any cause is present, or sites with poor perfusion.

Caution

Federal law restricts this device to sale by or on the order of a physician.

Sterilization

The CorNeat EverPatch is sterilized by EtO- Ethylene Oxide. The device is provided in a sterile double blister.

Storage

Store the CorNeat EverPatch in a clean and dry environment at room temperature. Keep away from direct sunlight or extreme temperatures.

Potential Complications

The surgeon should inform the patient of potential complications which may occur following CorNeat EverPatch implantation:

- Patient discomfort from inflammation which can occur due to foreign body reaction.
- Detachment of the device from surrounding tissue in case of trauma or when chronic inflammation is not addressed.

The surgeon should instruct the patient to seek immediate medical attention if any of these complications are observed.

Report any serious incident occurring in relation to the device:

CorNeat Vision complaints: complaints@corneat.com 1-507-267-6328	Food and Drug Administration MedWatch: https://www.accessdata.fda.gov/scripts/medwatch/index.cfm 1-800-332-1088
--	---

Precautions

- Prior to use, the surgeon must become familiar with the device and the surgical procedure.
- The device should not be implanted directly under a conjunctival incision.
- Use the device on a single occasion for a single patient. Once the package is opened, the device must be used for the on-going procedure or discarded.
- Inspect the packaging and labeling. Do not use if the package is opened or damaged. Do not use past the expiration date printed on the label. Do not use if label information is not legible.
- The device's sterile pack is comprised of 2 sealed blisters. Each of the blisters forms a complete sterile barrier. Apply sterile product handling techniques for device preparation prior to implantation.
- An additional CorNeat EverPatch device should be immediately available in case of unexpected need during the procedure.
- Do not re-sterilize.

Instructions for Use

It is important to read and understand the following instructions prior to use. Improper technique may adversely affect the success of the surgical procedure.

CorNeat EverPatch preparation and implantation







- Open the outer blister and place the inner blister on a sterile area.
- Open the inner blister and remove the protective holder.
- Carefully open the protective holder and remove the CorNeat EverPatch using forceps or a similar tool.
- Hydrate the device prior to use by soaking it in a sterile saline solution at room temperature. Antibiotic agents may be added to the soaking saline at surgeon's discretion.
- Closure of the conjunctival wound should not be performed directly above the CorNeat EverPatch. Perform the conjunctival incision distant from the surgical field.
- The CorNeat EverPatch is designed to be used as supplied, no trimming is necessary. Use the device as supplied- **do not trim.**
- Suture the device to the sclera through the suturing holes, using minor to moderate tension. Sutures may pass through the matrix if needed.





Follow-up

Periodic follow-up is recommended- an ophthalmologist should verify the CorNeat EverPatch's integrity and examine the surrounding tissue every 6 months.

Symbols Glossary

Symbol	Title	Description	Standard	Reference Number
REF	Catalogue number	Indicates the manufacturer's catalogue number so that the medical device can be identified	ISO 15223-1 Fourth edition 2021-07: Medical devices - Symbols to be used with information to be supplied by the manufacturer - Part 1: General requirements	5.1.6
#	Model number	Indicates the model number or type number of a product	ISO 15223-1 Fourth edition 2021-07: Medical devices - Symbols to be used with information to be supplied by the manufacturer - Part 1: General requirements	5.1.10
LOT	Batch code	Indicates the manufacturer's batch code so that the batch or lot can be identified	ISO 15223-1 Fourth edition 2021-07: Medical devices - Symbols to be used with information to be supplied by the manufacturer - Part 1: General requirements	5.1.5

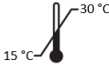
Symbol	Title	Description	Standard	Reference Number
	Use-by date	Indicates the date after which the medical device is not to be used	ISO 15223-1 Fourth edition 2021-07: Medical devices - Symbols to be used with information to be supplied by the manufacturer - Part 1: General requirements	5.1.4
	Consult instructions for use or consult electronic instructions for use	Indicates the need for the user to consult the instructions for use	ISO 15223-1 Fourth edition 2021-07: Medical devices - Symbols to be used with information to be supplied by the manufacturer - Part 1: General requirements	5.4.3
R only	Prescription only	Federal law restricts this device to sale by or on the order of a physician	Guidance for Industry and FDA on Alternative to certain Prescription Device Labeling Requirements	N/A
	Manufacturer	Indicates the medical device manufacturer	ISO 15223-1 Fourth edition 2021-07: Medical devices - Symbols to be used with information to be supplied by the manufacturer - Part 1: General requirements	5.1.1
	Do not re-use	Indicates a medical device that is intended for one single use only	ISO 15223-1 Fourth edition 2021-07: Medical devices - Symbols to be used with information to be supplied by the manufacturer - Part 1: General requirements	5.4.2
	Sterilized using ethylene oxide	Indicates a medical device that has been sterilized using ethylene oxide	ISO 15223-1 Fourth edition 2021-07: Medical devices - Symbols to be used with information to be supplied by the manufacturer - Part 1: General requirements	5.2.3
	Do not use if package is damaged and consult instructions for use	Indicates that a medical device that should not be used if the package has been damaged or opened and that the user should consult the instructions for use for additional information	ISO 15223-1 Fourth edition 2021-07: Medical devices - Symbols to be used with information to be supplied by the manufacturer - Part 1: General requirements	5.2.8

Symbol	Title	Description	Standard	Reference Number
	Double sterile barrier system	Indicates two sterile barrier systems	ISO 15223-1 Fourth edition 2021-07: Medical devices - Symbols to be used with information to be supplied by the manufacturer - Part 1: General requirements	5.2.12
	Do not resterilize	Indicates a medical device that is not to be resterilized	ISO 15223-1 Fourth edition 2021-07: Medical devices - Symbols to be used with information to be supplied by the manufacturer - Part 1: General requirements	5.2.6
	Keep away from sunlight	Indicates a medical device that needs protection from light sources	ISO 15223-1 Fourth edition 2021-07: Medical devices - Symbols to be used with information to be supplied by the manufacturer - Part 1: General requirements	5.3.2
	Temperature limit	Indicates the temperature limits to which the medical device can be safely exposed	ISO 15223-1 Fourth edition 2021-07: Medical devices - Symbols to be used with information to be supplied by the manufacturer - Part 1: General requirements	5.3.7
	MR Safe	An item that poses no known hazards resulting from exposure to any MR environment. MR Safe items are composed of materials that are electrically nonconductive, nonmetallic, and nonmagnetic.	ASTM F2503 – 20 Standard Practice for Marking Medical Devices and Other Items for Safety in the Magnetic Resonance Environment	7.3.1

Manufacturer

CorNeat Vision, Ltd.

4 Hasheizaf St, Raanana

Israel 4366411

E-mail: info@corneat.com

Website: www.corneat.com